

H-1X

Quick Setup Instructions

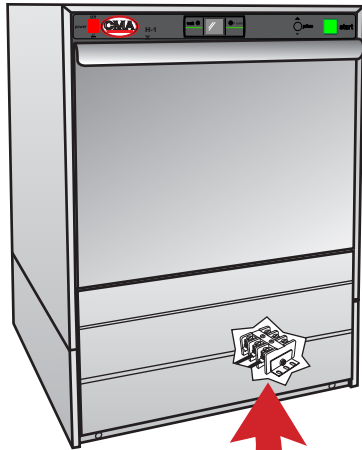

WARNING: Electrical and plumbing connections need to be made by a qualified service person who will comply with all available Federal, State and Local Health, Electrical, Plumbing and Safety codes.



THE DRAIN HOSE IS LOOPED AND CLAMPED AND MUST NOT BE CHANGED. ALTERING THE DRAIN HOSE ROUTING MAY RESULT IN THE MACHINE'S INABILITY TO DRAIN OR MAY CAUSE THE MACHINE TO SIPHON THE WATER OUT OF THE MACHINE.

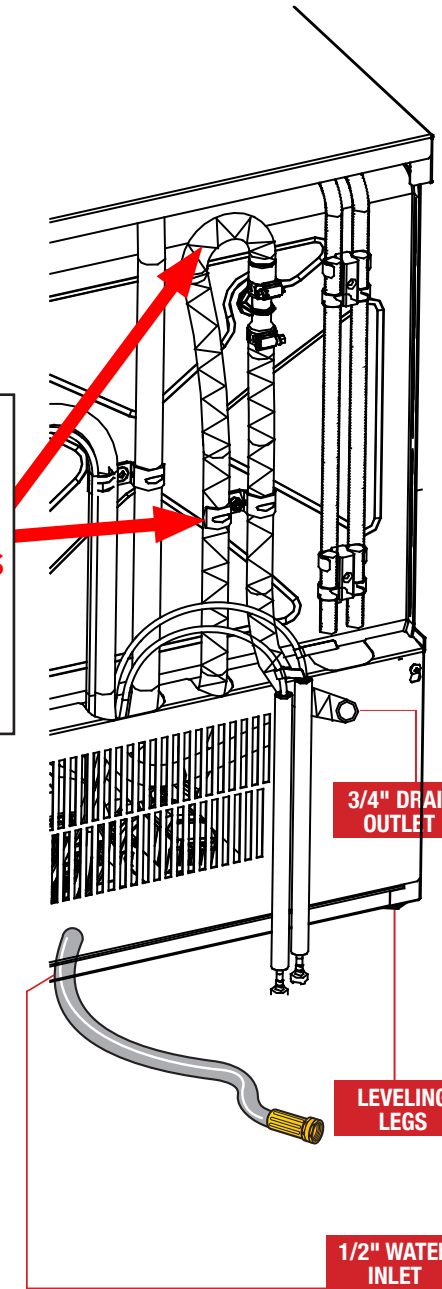

! VERY IMPORTANT !

Plumbing connections must be made **BEFORE** electrical installation begins. Damage to the water heaters will occur if power is turned on without adequate water supply.

The dishwasher will not drain correctly if it is connected to a disposer.

STEP

1

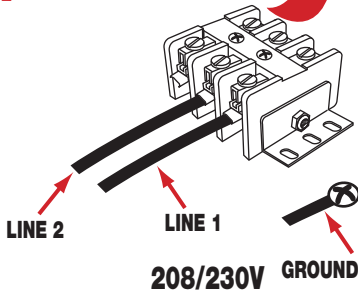

Connect lines 1 and 2 to electrical block located inside front panel.

STEP

2

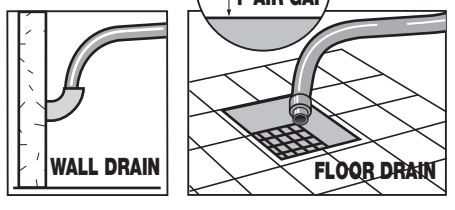

Connect the drain hose to wall or floor drain. The floor drain must have a 1 inch air gap between drain hose and floor drain.

STEP

3

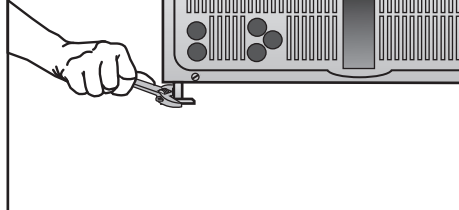

Level dishmachine by adjusting leveling legs. Dishmachine must be level front to back and side to side ensure proper performance.

STEP

4

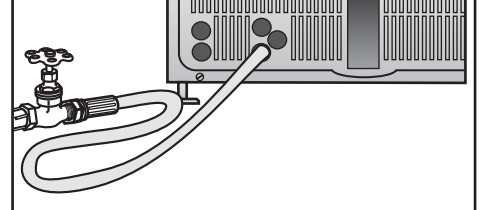

Connect dishmachine to hot water source, minimum temperature 120F, better results at 140F.

H-1X

Quick Setup Instructions

WARNING: Electrical and plumbing connections need to be made by a qualified service person who will comply with all available Federal, State and Local Health, Electrical, Plumbing and Safety codes.

H-1X FRONT VIEW

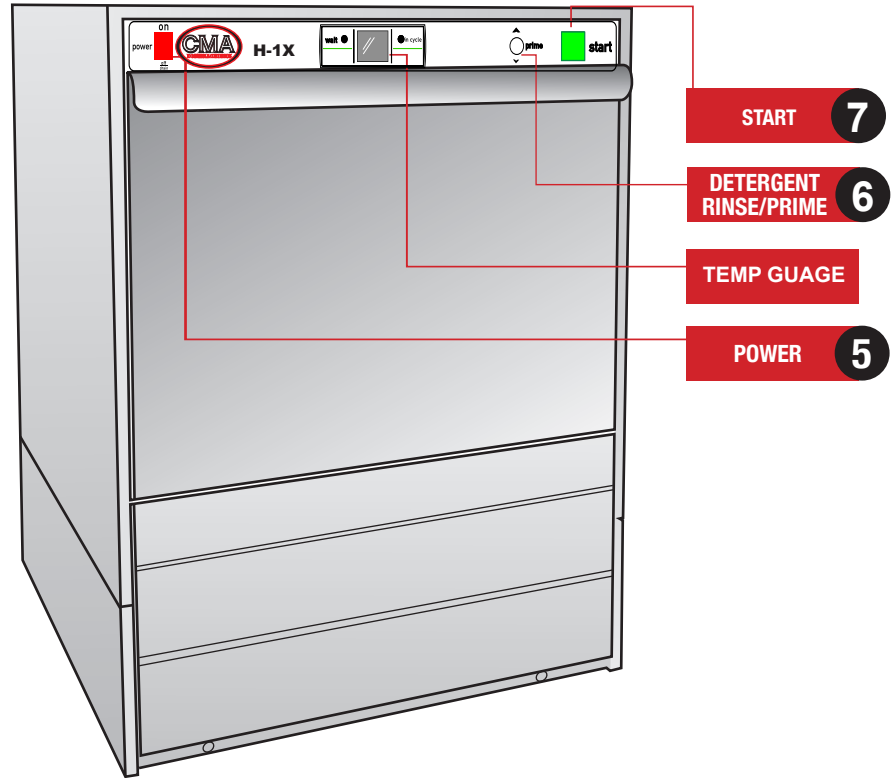

BOOSTER FILL PROCEDURE

1. **DO NOT TURN THE DISHMACHINE POWER SWITCH ON.**
2. Turn the water supply to the machine on.
3. Turn the breaker or disconnect on.
4. **PRESS and HOLD** the dishmachine start switch for 3 seconds to activate the fill solenoid.
5. Continue to hold the start switch until water enters the wash tank.
6. Release the start switch.
7. Booster pre-fill is complete.



The chemical pumps must be primed (using the prime switch) before the dishmachine is operated .

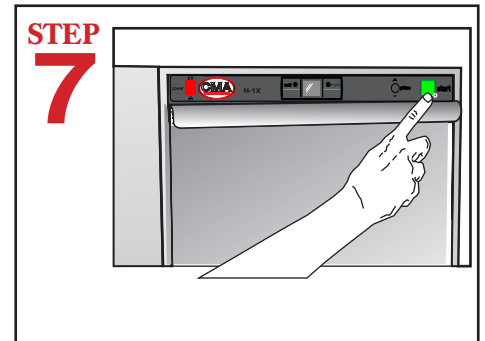

Push the "START" button to start the dishmachine cycle.

