

# L-1X16 / L-1X

REAR VIEW



## Quick Setup Instructions

**WARNING:** Electrical and plumbing connections need to be made by a licensed service person and comply with all Federal, State and Local Health, Electrical, Plumbing and Safety codes.

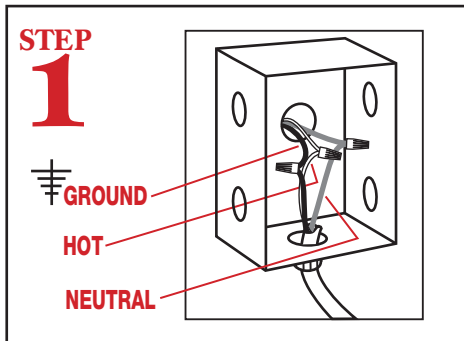
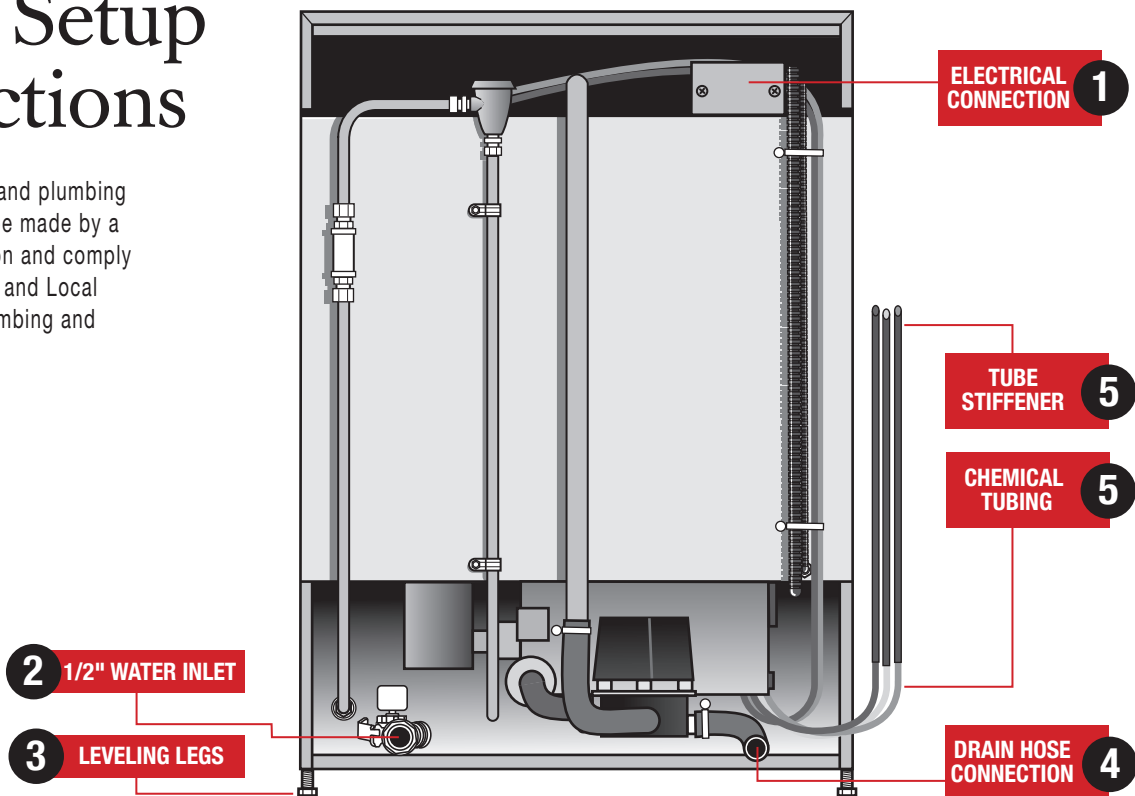

Connect 110/120V, 60HZ hard wired power supply to power box. **DO NOT USE POWER CORD OR GFI OUTLET.**

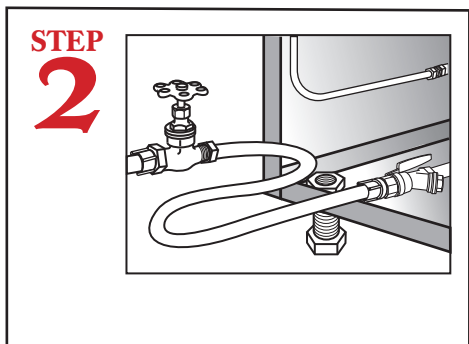

Connect dishmachine to hot water source recommended 140° temperature (120° minimum temperature required).

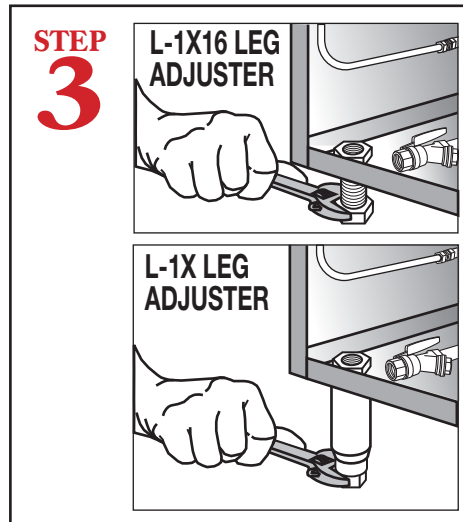

Level dishmachine by adjusting leveling legs. Dishmachine must be level front and back to ensure proper performance.

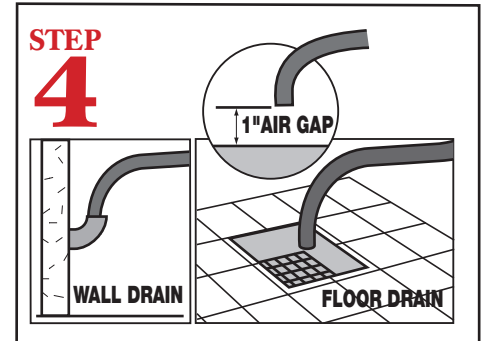

Connect the drain hose to wall or floor drain. The floor drain must have a 1 inch air gap between drain hose and floor drain.

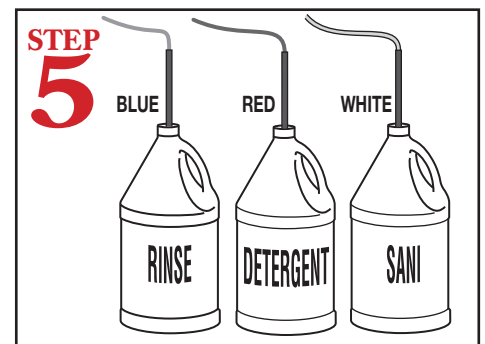

Insert tube stiffener with chemical tubing into corresponding chemical dispensers.

# L-1X16 / L-1X

## Quick Setup Instructions



FRONT VIEW

**WARNING:** Electrical and plumbing connections need to be made by a licensed service person and comply with all Federal, State and Local Health, Electrical, Plumbing and Safety codes.

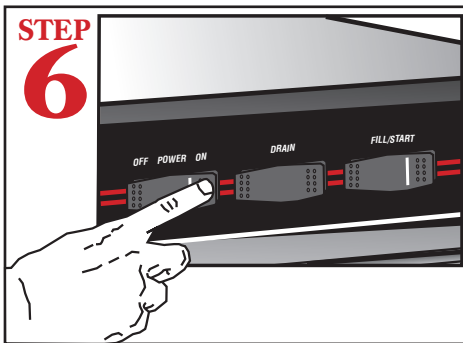
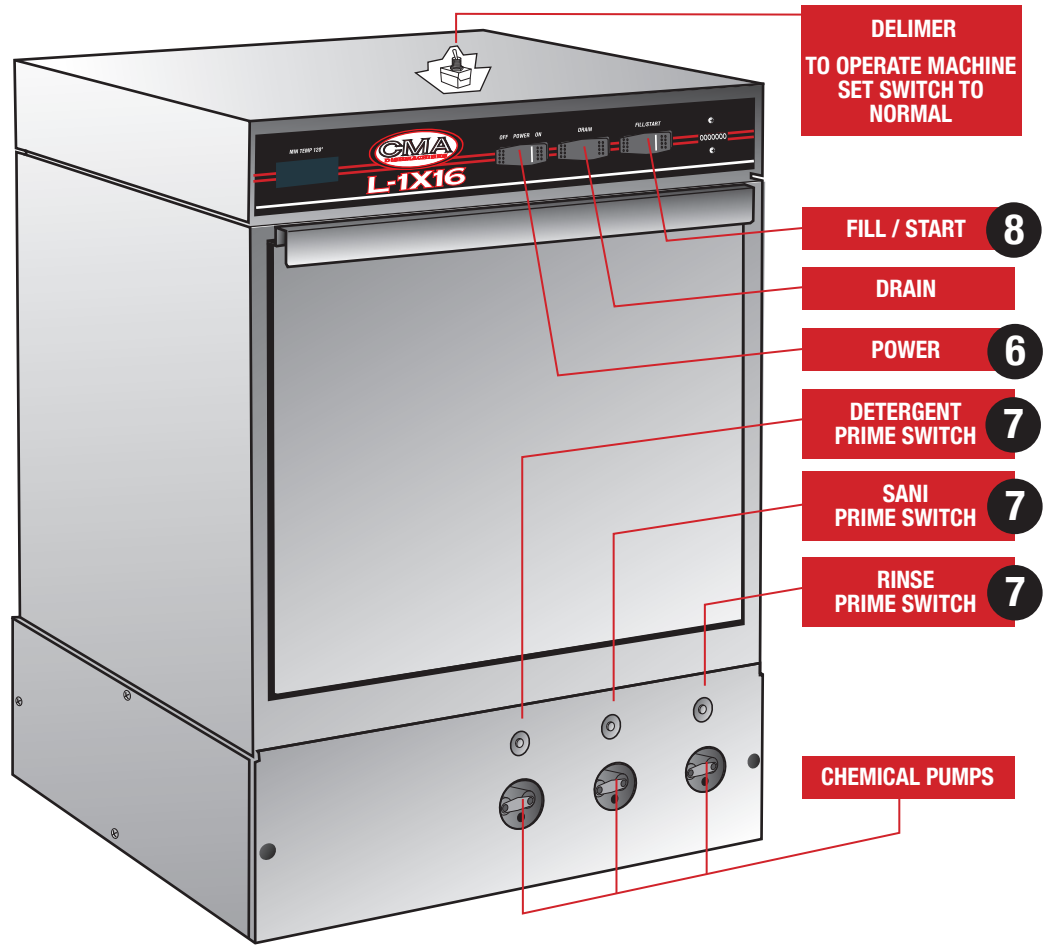

Turn power switch to "ON" position.

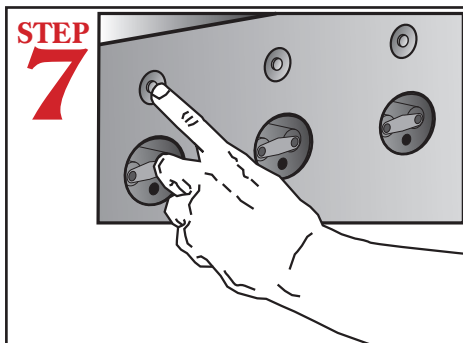

Press and Hold down "SANI", "DETERGENT" and "RINSE" switches to prime chemicals. This step must be repeated each time chemical containers are changed.

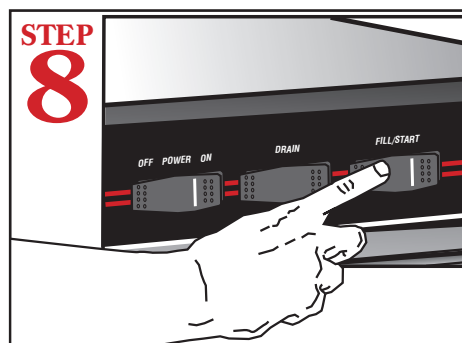

Hold down "FILL" Switch for approximately 10 - 15 seconds to allow water to flow into the dishwasher. Water should reach "FILL LINE" which is located inside at the back of the wash tank. Close door, then press "START" switch.

**NOTE:** The 4th cam of timer assembly has to be adjusted to maintain the same water level during the cycle.

