

Models AH, C, B, CB and Scullery B Quick Setup Instructions

WARNING: Electrical and plumbing connections need to be made by a licensed service person and comply with all Federal, State and Local Health, Electrical, Plumbing and Safety codes.

MODEL AH REAR VIEW

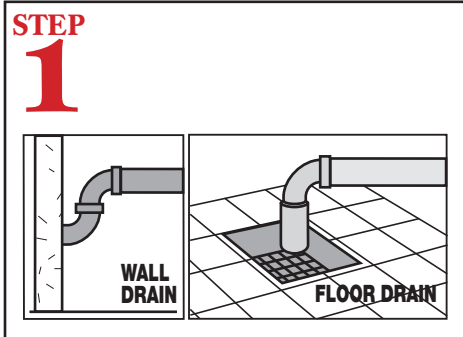
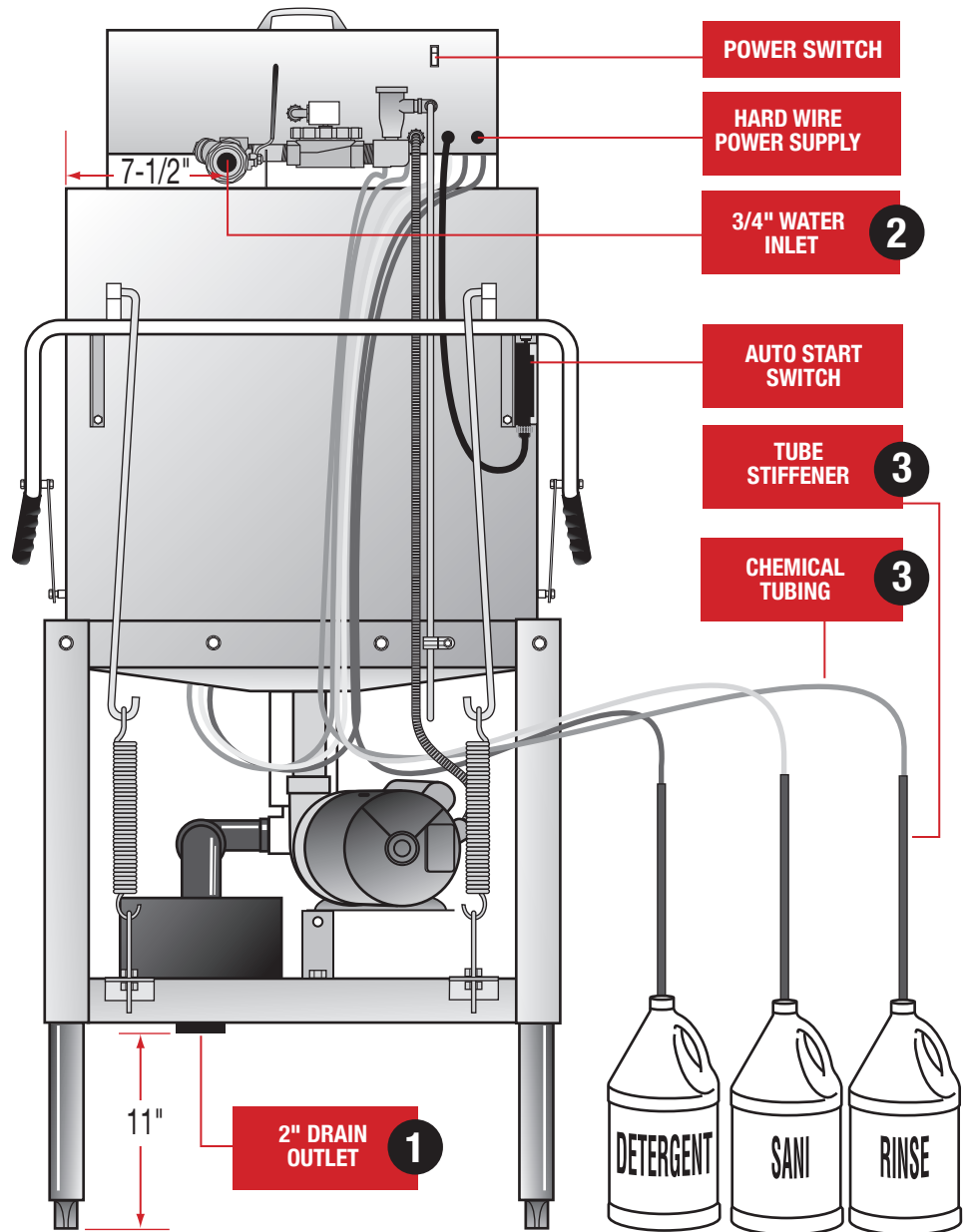

Connect the drain pipe from scrap accumulator to floor or wall drain.

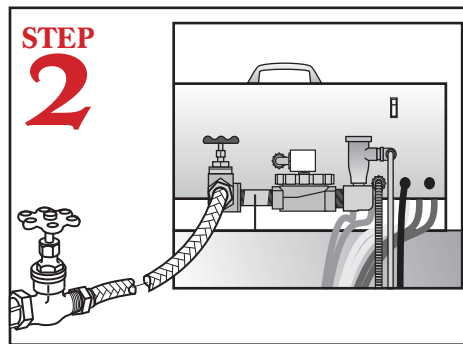

Connect dishmachine to hot water source recommended 140 temperature (120 minimum temperature required).

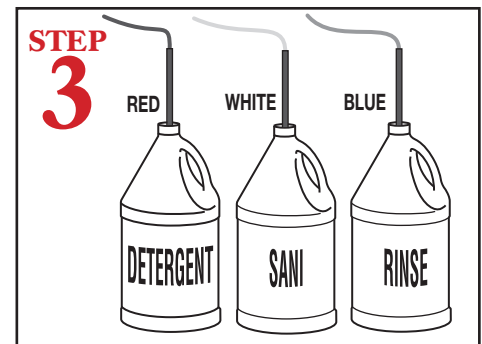

Insert tube stiffener with chemical tubing into each corresponding chemical dispensers.

Models AH, C, B, CB and Scullery B Quick Setup Instructions

MODEL AH FRONT VIEW

WARNING: Electrical and plumbing connections need to be made by a licensed service person and comply with all Federal, State and Local Health, Electrical, Plumbing and Safety codes.

5 PRIMER SWITCHES

FILL/START SWITCH **6**

PERISTALTIC PUMP

DOOR HANDLE **7**

THERMOMETER

POLY PRO™ SCRAP ACCUMULATOR

LEVELING LEGS **4**

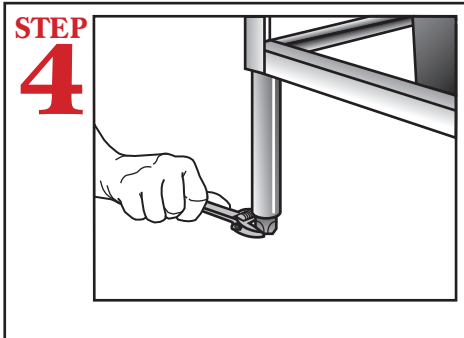

Level dishmachine by adjusting leveling legs. Dishmachine must be level front and back to ensure proper performance.

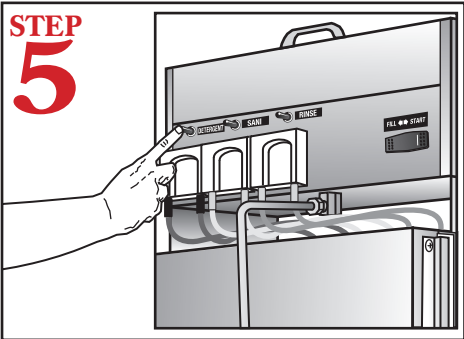

Press and hold down the three Primer Toggle Switches for the chemical pumps until product is discharging into the machine.

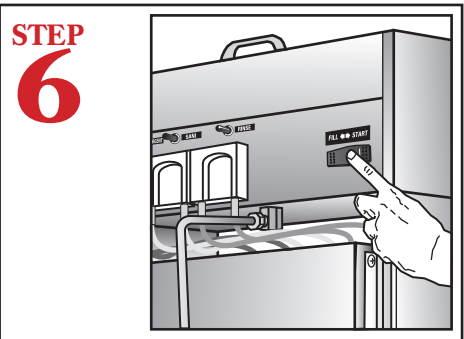

Press and hold the Fill/Start Switch until the water level is approximately 1/2" to 3/4" below the overflow hole in the PVC standpipe.

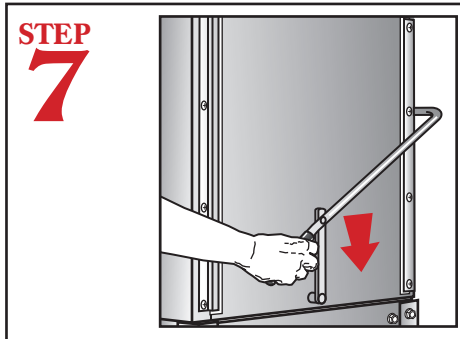

To start machine close the doors. The machine will automatically start and run through its cycle.