



Owner's Manual

MODEL CMA-181VL

INSTALLATION & OPERATION

Rev 1.01 05-2019



CMA DISHMACHINES
12700 KNOTT STREET
GARDEN GROVE, CALIFORNIA 92841

800-854-6417

FAX 714-895-2141

www.cmadishmachines.com

TABLE OF CONTENTS

MODEL CMA-181VL

| | |
|---|-----------|
| 1. SPECIFICATIONS | 2 |
| 1.1. CMA-181VL | 2 |
| 1.2. CMA-181VL OPERATIONAL CYCLE | 3 |
| 2. GETTING STARTED..... | 5 |
| 2.1. INTRODUCTION TO CMA-181VL | 5 |
| 2.1.1. <i>Plumbing Chart</i> | 6 |
| 2.2. RECEIVING AND INSTALLATION..... | 7 |
| 2.2.1. <i>Electrical</i> | 7 |
| 2.2.2. <i>Plumbing</i> | 7 |
| 2.2.3. <i>Detergent And Rinse Chemical Dispenser (Optional)</i> | 8 |
| 2.2.4. <i>Safe -T- Temp Feature</i> | 8 |
| 2.2.5. <i>Booster Heater Setup</i> | 9 |
| 2.2.6. <i>Installer Checklist</i> | 9 |
| 3. OPERATION | 10 |
| 3.1. INITIAL SETUP | 10 |
| 3.1.1. <i>Rinse and Wash Temperatures</i> | 10 |
| 3.1.2. <i>Post Instructions</i> | 10 |
| 3.2. STARTUP PROCEDURES..... | 10 |
| 3.3. OPERATING AND CLEANING INSTRUCTIONS | 11 |
| 3.4. PREVENTIVE MAINTENANCE CHART | 12 |
| 3.5. QUICK SERVICE GUIDE..... | 13 |
| 3.6. TROUBLESHOOTING..... | 14 |
| 4. PARTS KIT | 17 |
| 4.1. INITIAL PARTS KIT | 17 |
| 5. CUSTOMER NOTICE | 18 |
| 6. ELECTRICAL DIAGRAM..... | 19 |
| 6.1. CONTROL PANEL | 19 |
| 6.2. ELECTRICAL TRAY | 20 |

1. Specifications

| 1.1. CMA-181VL | METRIC EQUIVALENT | |
|--|--------------------------------|--------------------------------|
| WATER CONSUMPTION | | |
| PER RACK | 0.73 GAL. | (2.76 L) |
| PER HOUR | 12.4 GAL. | (46.93 L) |
| OPERATING CYCLE | | |
| WASH TIME-SEC | 96 | 96 |
| RINSE TIME-SEC | 14 | 14 |
| DWELL TIME-SEC | 3 | 3 |
| VENT FAN -SEC | 65 | 65 |
| TOTAL CYCLE-SEC | 178 | 178 |
| OPERATING CAPACITY | | |
| RACKS PER HOUR | 17.3 | 17.3 |
| WASH TANK CAPACITY | 2.5 GAL. | (9.46 L) |
| PUMP CAPACITY | 38 GPM | (144 LPM) |
| WATER REQUIREMENTS | | |
| COLD WATER TEMP | 41°F-65°F | (5°-18°C) |
| WATER INLET | ½" | 1.27cm |
| DRAIN CONNECTION | 1" | 2.54cm |
| CYCLE TEMPERATURES | | |
| WASH-°F | 150°F -160°F | (65.5°C/71°C) |
| RINSE -°F | 180°F -195°F | (82°C/90°C) |
| FRAME DIMENSIONS | | |
| DEPTH | 27" | (68.6 cm) |
| WIDTH | 24" | (60.96 cm) |
| HEIGHT | 33-3/4" | (85.725) |
| MAX CLEARANCE FOR GLASSWARE | 11-1/4" | (28.6 cm) |
| ELECTRICAL RATING* | 208 VOLTS 1 PH—60 Hz | 230 VOLTS 1 PH—60 Hz |
| | 33 AMPS | 35 AMPS |
| BOOSTER HEATER | 5.3 kW | 6.5 kW |
| WASH PUMP MOTOR | 1 HP | 1 HP |
| THIS SYSTEM REQUIRES THREE POWER WIRES, WHICH INCLUDES A CURRENT CARRYING NEUTRAL. AN ADDITIONAL FOURTH WIRE MUST BE PROVIDED FOR MACHINE GROUND.NO GFI BREAKER. | | |
| SHIPPING WEIGHT | 234# | (106 kg) |

* For machines having "SAFE-T-TEMP" feature. ** For faster heat recovery.

Note: The required flowing water pressure to the dishwasher is 30-65 PSIG. If pressures are higher than 65 PSIG, a pressure regulating valve must be installed in the water line to the dishmachine (by a qualified person). If flow pressure is lower than 30 PSIG, improper operation may result.

1.2. CMA-181VL Operational Cycle

The CMA-181VL Operational Cycle (including water vapor evacuation) has a total cycle time of three (3) minutes (180 seconds). The Timing Diagram and the steps listed below detail the individual functions that are executed during each Operational Cycle.

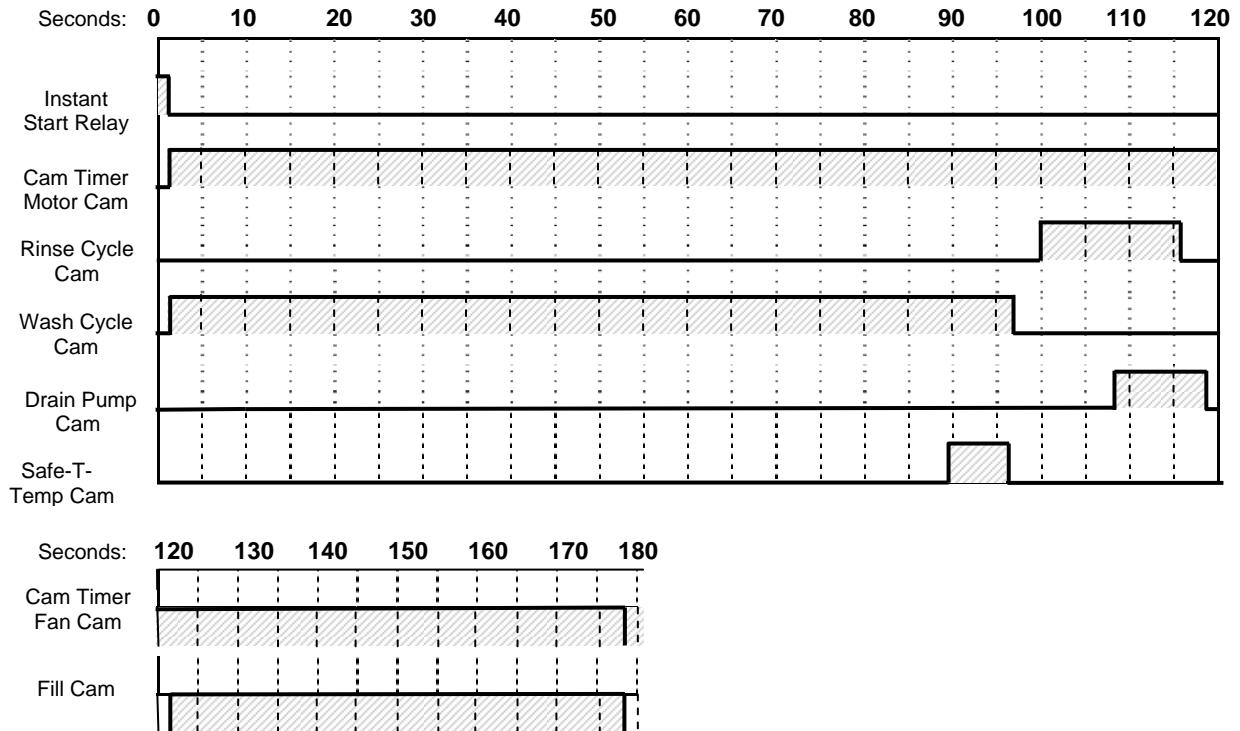

1. With the machine powered up, toggling the START switch begins a cycle.
 - a) Toggling the START switch energizes both the Cam Timer motor and the Instant Start Relay. The Instant Start Relay latches ON the power to the Cam Timer motor so that the START switch can be released a moment after it has been toggled without the Cam Timer motor losing power.
 - b) After about 1.5 seconds the Cam Timer's first cam—the Cam Timer Motor Cam—latches ON the power to the Cam Timer motor and drops out the Instant Start Relay. The Cam Timer motor continues to run for a total of 3 minutes, at which time it switches OFF—resetting the Cam Timer—and waits for the next START command.
2. The Cam Timer's third cam controls the Wash Pump. The Wash Pump comes ON about 3 seconds into the Operational Cycle and continues to run for 96 seconds. This 96-second period is the Wash Cycle.

3. The Cam Timer's fourth cam powers ON the Drain Pump midway through the Rinse Cycle and stays ON for 10 seconds, turning OFF 2 seconds after the Rinse Cycle has completed. 3 seconds after the Wash Cycle has completed the Cam Timer's second cam, which controls the Rinse Cycle, turns ON—energizing the Water Solenoid—and stays ON for 14 seconds. This 14-second period is the Rinse Cycle.
4. After the Rinse Cycle is completed Cam Timer's sixth cam turns Fan for 60 seconds steam evacuation.
5. The Cam Timer's seventh cam controls the fill. The fill comes on 2 seconds after the fan starts. Water fills into the booster until the fill pressure switch senses that the booster is full and closes the water fill solenoid. The water fill solenoid will close before cam timer times out.
6. When the Cam Timer assembly approaches the final rinse portion of the cycle, the "Safe-T-Temp" fifth micro switch will pause the cam timer assembly if the booster heater has not reached 180 degrees. The Dishmachine will remain in wash cycle mode until a minimum 180-degree rinse temperature is reached, at which time the Cam Timer will advance automatically into the rinse cycle and dispense 180 degree rinse water over the glasses.



2. Getting Started

2.1. Introduction to CMA-181VL

The CMA-181VL is a hot water sanitizing, single rack, under-counter glass washer. It is a stand-alone machine featuring a self-contained booster heater. The only external connections necessary are power supply, **cold** water supply, drain pipe, and chemical dispensers. The glass washer uses re-circulated wash water and a fresh water final-rinse.

The unit is equipped with a built in Heat Recovery System which significantly reduces the water vapor created during the wash and rinse cycles. The Heat Recovery System uses the heat from the water vapor generated during the wash and rinse cycles to warm up the incoming cold water (41F -65F) before entering the booster heater.

Operation of the CMA-181VL is extremely user friendly. To initially fill the machine each day, push the Power switch to the "ON" position. The glass washer will be automatically filled to the correct level.

The booster tank heater will maintain the wash water temperature at approximately 155°F. The booster heater will produce a minimum of 180°F final rinse water each cycle.

The cold water supply to the CMA-181VL must be between 41°F - 65°F at a minimum 30 PSI. (Pounds per Square Inch) with a 6 GPM (Gallons per Minute) flow rate and 60 GPH (Gallons per Hour) recovery rate. The pipe supplying the water must be ½" minimum. The plumbing connection is located at the lower right rear of the glass washer (if facing the front). (See specification sheet on page 2).

This manual is structured to provide a complete reference guide to the CMA-181VL. It is presented in a manner that all users will be able to comprehend and use as an effective tool in supporting the operation and maintenance of the glass washer. The first section explains how the unit is packaged and what to look for when receiving the glass washer.

After unpacking the glass washer, this manual explains how to install and set up for proper operation. Requirements are given for plumbing, wiring, and space considerations. Guidance is given for installation to ensure that the glass washer will be able to operate at optimum levels.

The Operation Section of the manual may be used for instruction and procedures when required. We make this portion of the manual easy to understand so that all levels of operators may be able to read and comprehend the operation of the machine. The function of the glass washer itself is mostly automatic and takes little training to put into full operation. The Operation Section also includes diagnostic considerations for the machine when problems occur.

We are committed to providing the best machines and customer service in the food industry and your feedback is welcome.

DISCLAIMERS

CMA expressly disclaims any and all warranties, express or implied, relating to the installation of any and all CMA equipment that is installed by chemical dealers, contracted servicers or third party servicers to CMA equipment. If the installation instructions are not followed exactly (to the letter), or, if any person or company conducting the installation of the CMA equipment, revise the installation procedures or alter the instructions in any manner, the CMA warranty becomes void. If, due to the improper installation of CMA equipment, this equipment ceases to operate properly or affects other parts of the CMA dishwashing equipment, in that the other parts become defective, the CMA warranty becomes void. CMA will not be liable or responsible or warrant CMA equipment, due to improper installation of any CMA model dishwasher.

CMA does NOT endorse "Tankless On-Demand" water heaters for use on CMA Dishmachine products. On most applications, the volume of hot water required for commercial dishmachines exceeds the capacity of these types of heating sources. You will find that most, if not all, commercial dishmachines have been programmed with auto-filling features that require quick filling, with a designated limited time.

CMA DOES endorse, and highly recommends, the standard "tank" style water heaters, sized properly to handle each particular facility with their water heating requirements. A "tank" style water heater stores and supplies a large capacity of preheated water before providing hot water to the dishmachine. To meet required health codes, there must be a reliable and consistent flow of adequate hot water supplied to the dishmachine. If the facilities' "tank" style water heater is marginal in size, CMA recommends installing a proper size Hatco Booster Heater, a CMA's E-Temp 40 or 70-degree-rise Booster Heater (that can be installed on CMA Conveyors), or a CMA Temp-Sure Booster Heater (for door and undercounter dishmachines). All are designed to adequately achieve results.

Warning: cancer and reproductive harm – www.P65Warnings.ca.gov

2.1.1. Plumbing Chart

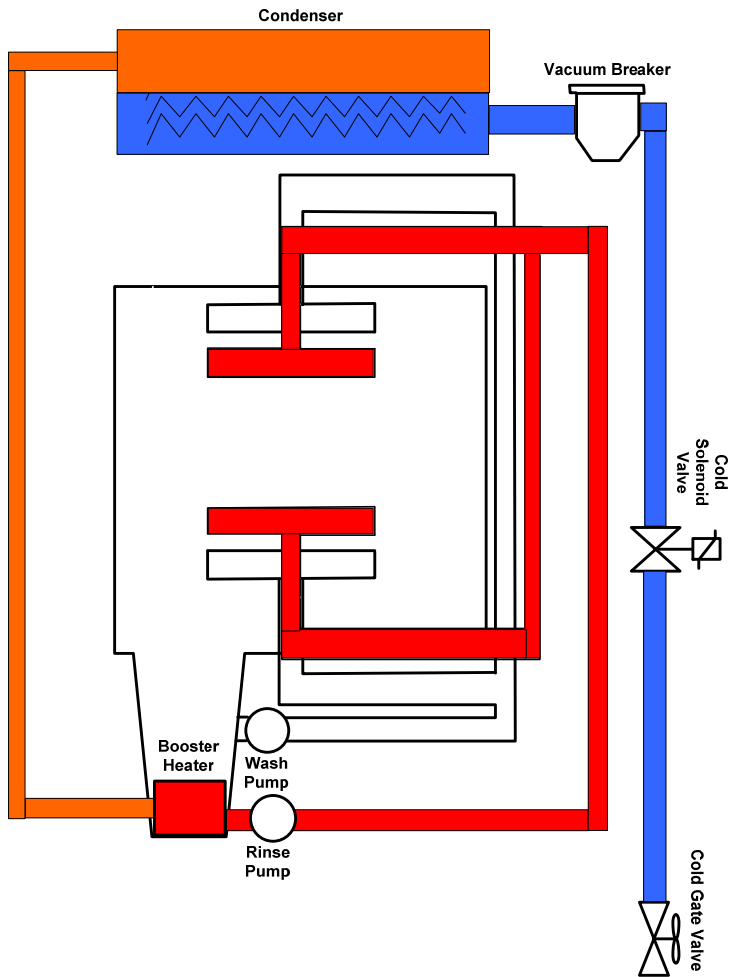

The building's cold tap water (41F-65F) connects to the stainless steel braided hose at the rear of the glass washer. The cold / ambient water travels from there through the condenser to the unit's booster heater. At the end of operating cycle, hot/humidified air inside the wash chamber is circulated past the condenser coils, raising the temperature of the incoming water flowing through those coils to approximately 130F to 140F degrees before entering the booster heater. The booster heater, located below the wash chamber, will raise the final-rinse water temperature to approximately 180F to 190F degrees ensuring a proper sanitizing final-rinse. The glass washer has a SAFE-T-TEMP feature which will extend the wash cycle if the final rinse temperature in the booster heater has not reached a minimum 180F. After an operating cycle is finished, which is indicated by the "CYCLE" light turning off, the fan circulating the air inside the wash chamber will continue to run an extra 65 seconds. This allows additional condensation removal. Opening the door anytime after the operating cycle is finished and before the fan has timed out, will stop the fan and allow the start of a new cycle.

2.2. Receiving and Installation

The glass washer is shipped from the factory in a corrugated box on a wooden pallet. The installation guidelines give a systematic procedure for setting up the glass washer.

Start by removing the packaging material. Unwrap the unit and check for the following component parts:

The Wash Tank Scrap Screen is shipped inside the wash cavity. This screen MUST be in place during operation to strain the water circulating through the pump assembly and spray arms, catching the broken glass or debris that could otherwise clog the pump impeller and plug the spray arms.

Set the unit in place, and level from side-to-side and front-to-back to prevent door leaks.

Some water vapor generated from normal operation may escape from the door jambs. Wood, laminates, veneers, etc. are unsuitable materials for use in areas exposed to this escaping water vapor and detergents. Stainless steel or other moisture-resistant shields are recommended for surfaces adjacent to sides and tops of under counter glass washers.

2.2.1. Electrical¹

Prior to installation make sure the electrical supply is compatible with the specifications on the glass washer data plate.

A single-phase 230 volt, 60 Hz dedicated circuit should be used to supply electrical energy to the CMA-181VL glass washer (see specification sheet page 2). This system requires three power wires, which include a current carrying neutral. An additional fourth wire must be provided for ground. Approximately 4-feet of ¾" flexible conduit with power leads (L-1, L-2, Neutral and Ground) extending out of the conduit are provided for easily connecting the power at installation. The power connection must be located such that there is sufficient length of the flexible conduit remaining to permit the unit to be moved for cleaning.

WARNING: Electrical and grounding connections must comply with the applicable portions of the National Electrical Code and/or other local electrical codes.

Note: For supply connections, use copper wire only rated at 90 degree C minimum.

2.2.2. Plumbing²

Notice to Plumber: The plumber connecting this unit is responsible for making certain that the water lines are THOROUGHLY FLUSHED OUT BEFORE connecting to the glass washer.

The unit is equipped with a 48" braided hose with ½" NPT connection located at the lower left-hand corner (facing the back) of the unit. A cold water line should be plumbed to this point (see specification sheet page 2). The water line used must be of sufficient length and flexibility to permit the unit to be moved for cleaning.

The pipe supplying the water must be ½" minimum. The plumbing connection is located at the back of the glass washer. (See specification sheet on page 2). **Note:** high iron levels in the water supply can cause staining and may require an iron filter. High chlorine levels in the water supply can cause pitting and may require a chloride removal system. If an inspection of the wash tank or booster heater tank reveals lime buildup after the glass washer has been in service, water treatment is recommended. If a water softener is already in place, ensure there is a sufficient level of salt.

^{1,2}All electrical and plumbing connections must be made by a qualified person and comply with all available Federal, State, and Local Health, Electrical, Plumbing and Safety codes listed in Sec.17.1 of UL921.

Warning:

CMA recommends utilizing a water softening system to maintain water hardness measurements of 3.5 gpg (grains per gallon) or less. This will assure maximum results and optimum operation of the dishmachine.

2.2.3. Detergent And Rinse Chemical Dispenser (Optional).¹

Optional built-in chemical dispenser Assembly (CMA P/N 14585.00) has easy access for chemical settings behind the front kick panel. Both initial charge and recharge is factory pre-set. Basic settings for both detergent and rinse speed are 50%. Operating fine-adjustment screws on the dispenser can control the amount of chemicals drawn into chemical lines.

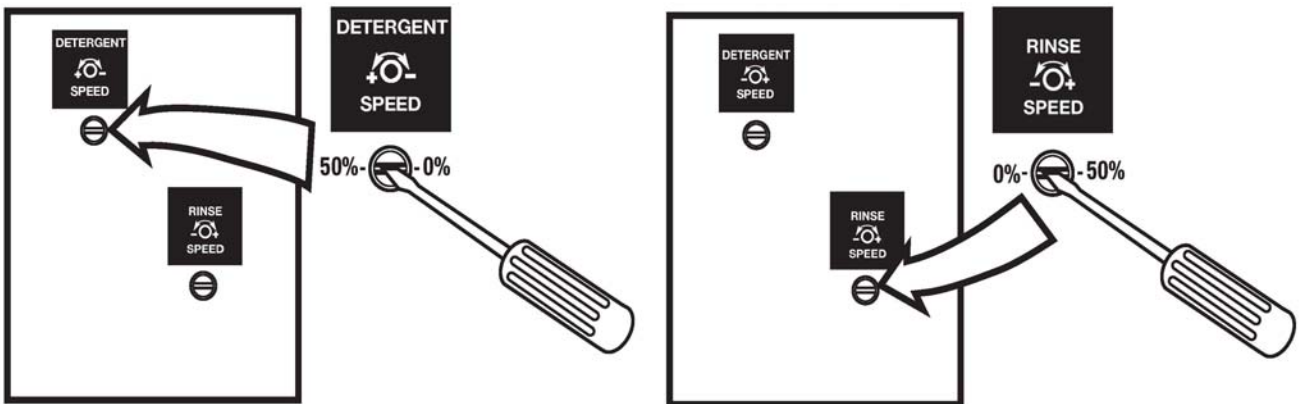

Undercounter machine with the optional dispenser must be ordered separately, as option at time of order. Optional dispenser has to be pre-wired prior to shipment (see electrical diagram for wiring options).

Note: Use only commercial-grade detergents and rinse aids recommended by your chemical professional. Do not use detergents and rinse aids formulated for residential dishwashers.

2.2.4. Safe -T- Temp Feature

The CMA “Safe-T-Temp” feature assures the final rinse cycle is always at a consistent minimum of 180 degrees.

How it works: the “Safe -T-temp” function operates off the 5th cam (labeled “Safe -T-Temp”) on the timer assembly. When the cam timer assembly completes the wash cycle, and approaches the final rinse portion of the cycle, the “Safe -T-Temp” micro switch will drop into the cam slot and pause the cam timer assembly if the booster heater has not reached 180 degrees. The glass washer will remain in wash cycle mode until 180 degree rinse temperature is met, and at this time the cam timer will advance automatically into the rinse cycle and dispense 180 degrees rinse water over the glasses.

¹ All electrical and plumbing connections must be made by a qualified person who will comply with all available Federal, State, and Local Health, Electrical, Plumbing and Safety codes

2.2.5. Booster Heater Setup

1. Turn the Power switch to the "ON" position.
The glass washer will be automatically filled with water to the correct level.
2. Turn the Power switch to the "OFF" position.

2.2.6. Installer Checklist

- Glasswasher checked for concealed damage**
- Cold water supply is 41°F - 65°F**
- Incoming water supply line is ½" — minimum**
- Incoming water supply is 30 PSI minimum.**
- Supply circuit breaker for glass washer that is properly sized (50 amp)**
- Service voltage and phase type are correct to unit's data plate**
- Drain hose is installed with air gap (discharge 1" above drain)**
- Glasswasher is properly grounded**
- Glasswasher is properly leveled**
- Circuit breaker is labeled "GLASSWASHER"**
- Glass washer has been "hard-wired" with correctly sized wire**



3. Operation

3.1. *Initial Setup*

3.1.1. Rinse and Wash Temperatures

1. Turn the Power switch to the "ON" position.
2. After the unit has warmed up, note the wash and rinse temperatures. The wash temperature must be 150°F minimum. The rinse temperature must be 180°F minimum³. If necessary, adjust the temperatures by removing the front kick panel and turning the thermostat adjustment clockwise to increase, counterclockwise to decrease. This adjustment controls the wash and rinse temperatures.

3.1.2. Post Instructions

1. Install wall chart and instruct the operator on proper cleaning and operation of the CMA-181VL.

3.2. *Startup Procedures*

1. Open the door of the unit and check that the scrap screen is in place, and that the spray arms and end plugs are secure.
2. Close the door and turn the Power switch to the "ON" position.
The glass washer will be automatically filled with water to the correct level.
3. Once the water is filled to the proper level, press the rocker switch marked "START" – the unit will automatically begin its cycle.
4. Check operating temperatures — Adjust if necessary. See section 3.1.1 Rinse and Wash Temperatures.
5. At the end of the wash period, drain the glass washer by pushing the rocker switch marked "DRAIN". Clean the wash tank screen and scrap tray screen. Remove and clean the spray arms. (See wall chart instructions).

³ Rinse cycle temperature must be observed during a rinse cycle while the unit is in operation..

3.3. Operating and Cleaning Instructions



OPERATING INSTRUCTIONS FOR MODEL CMA-181VL
INSTRUCCIONES DE OPERACION DE MODELO CMA-181VL



1 Turn on power and machine will be automatically filled to correct level.
 Prenda la maquina y auto-maticamente va a llenar al nivel correcto.

2 Start machine by pushing start button.
 Para empezar la maquina, cierre la puerta y oprima el boton de encendido.

CAUTION: DO NOT START until wash temperature reads 150°.
No empiece el lavado hasta que la temperatura sea 150°.

150°
 °F
 WASH TEMP 150°-160°

3 Drain machine by pressing and holding drain button.
 Para vaciar la maquina: Oprima y mantenga oprimido el boton de vaciado.

4 Turn off power.
 Apague La Maquina

5 If spray arms are clogged remove by turning bearings counter clockwise.
 Si los brazos de rociado se tapan, es necesario sacarlos desentrosandolos para el lado izquierdo.

6 Inspect top and bottom spray arm jets daily. Use toothpick and push debris into spray arm. Remove end plugs and flush with water. Use un picadientes (palillo) para abrir los orificios. Destapar por las puntas, removiendo el tapon y enjuagelos con agua.

7 Hand remove and thoroughly clean scrap basket under faucet or Pre-Rinse Hose every shift.
 Remueva el filtro de el interior de el tanque de desperdicios. Lave el filtro el cedazo con el rociador de agua cada turno.

8 Replace screen back into position.
 Reinstale el filtro apropiadamente.

1-2018

CMA PN: 06265.30

3.4. Preventive Maintenance Chart



PREVENTIVE MAINTENANCE



If rinse arm jets are clogged, remove rinse arm (by turning bearing counter clockwise) and clean out rinse jets with paper clip or small pointed object.

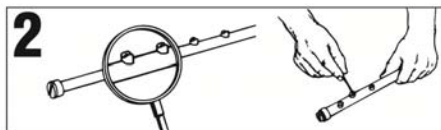

Inspect top and bottom spray arms daily. Use toothpick to push debris into spray arm. Remove end plugs and flush with water.

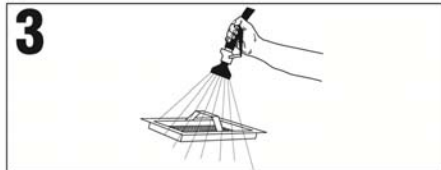

Remove and thoroughly clean scrap tray daily.

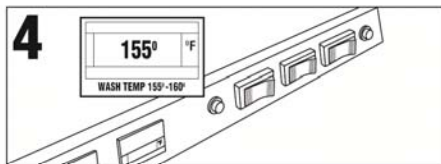

Confirm wash temperature is 155°F.

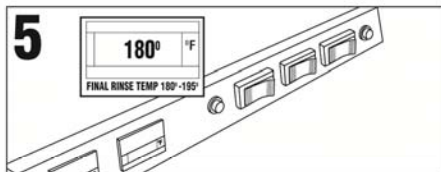

Check rinse temperature. Minimum 180°F. Notify supervisor if rinse temperature is below 180°F.



Check chemical containers for product. Confirm correct product line is in the bucket.
RED - Detergent
BLUE - Rinse Aid



Check machine for leaks.

3.5. Quick service guide

MODEL: CMA 181VL HIGH TEMP UNDER COUNTER

| TECHNICAL ISSUE | CAUSE | SOLUTION |
|-----------------------------------|--|------------------------------|
| Door leaks | Machine not level | Adjust machine legs to level |
| | Wash arm end cap missing | Replace end cap |
| | Door gasket | Replace gasket |
| Temperature Display failure | Loose wire at display, board or transformer | Secure connectors |
| | Faulty temperature sensing wire | Correct, replace |
| | Faulty temperature sensing unit | Replace unit |
| Rinse water temperature low /high | Faulty transformer | Replace transformer |
| | Scaled heating element | Clean scale from heater |
| Wash pump motor not running | Booster heater's thermostat not properly set | Adjust thermostat |
| | Loose lead connections | Check and crimp connectors |
| Wash pump motor runs continuously | Faulty # 3 micro switch | Replace micro switch |
| | Faulty contactor | Replace contactor |
| | Faulty wash pump motor | Replace wash pump motor |
| Poor cleaning results | Faulty # 3 micro switch | Replace micro switch |
| | Faulty contactor | Replace contactor |
| Wash tank will not drain | Low wash or rinse water temp. | Check temperature settings |
| | Wash arm bearing or clogged jets | Clean bearing and arm jets |
| | Rinse arm bearing or clogged jets | Clean bearing and arm jets |
| Wash tank will not drain | Tank discharge screen dirty | Clean screen |
| | Drain valve not operating | Check power to drain valve |
| | Drain valve faulty | Replace drain valve |
| | Drain pump faulty | Replace drain pump |

3.6. Troubleshooting

| PROBLEM | LIKELY CAUSE | SOLUTION |
|---------------------------|---------------------------------------|---|
| Machine inoperative | Power off at circuit breaker | Reset circuit breaker |
| | Defective power switch | Replace power switch |
| Motor inoperative | Door is open | Close door |
| | Control panel is pulled out | Secure control panel |
| | Defective reed switch | Replace reed switch |
| | Defective timer assembly | Replace timer assembly* |
| | Defective pump motor contactor | Replace contactor |
| | Defective motor | Replace motor |
| Motor runs with door open | Defective reed switch | Replace reed switch |
| | Defective pump motor contactor | Replace contactor |
| Heater (no heat) | High limit switch opened or defective | Reset or replace switch |
| | Defective thermostat | Replace thermostat |
| | Defective heater contactor | Replace heater contactor |
| | Defective heater | Replace heater |
| | Water level too low in booster tank | Add water to booster tank to activate air pressure switches |
| Heater (never turns off) | Defective thermostat | Replace thermostat |
| | Defective heater contactor | Replace heater contactor |

*The timer assembly motor or micro switches can be replaced independently.

Operation

| PROBLEM | LIKELY CAUSE | SOLUTION |
|---|--|---------------------------|
| Low heat during operation | Thermostat out of adjustment | Adjust thermostat |
| | Defective heater | Replace heater |
| Low rinse water flow | Limed up rinse arm spray nozzles | De-lime rinse arm nozzles |
| No rinse water flow | Defective rinse pump | Replace rinse pump |
| | Defective (Rinse Relay) ice cube relay | Replace ice cube relay |
| Rinse water runs with door open | Defective reed switch | Replace reed switch |
| With power on, activating start switch does not begin cycle | Defective start switch (cycle light will not light either) | Replace start switch |
| | Defective timer assembly | Replace timer assembly* |

*The timer assembly motor or micro switches can be replaced independently.

| | | |
|--|--|------------------------------|
| Start switch requires > 1 second activation to run cycle | Defective (Instant Start) ice cube relay | Replace ice cube relay |
| Fill won't shut off | Defective water solenoid valve | Replace water solenoid valve |
| | Defective timer assembly | Replace timer assembly* |
| | Defective ice cube relay | Replace ice cube relay |
| Activating drain switch does not drain machine | Drain hose is kinked | Un-kink drain hose |
| | Defective drain switch | Replace drain/fill switch |
| | Defective drain valve | Replace drain valve |
| | Defective drain pump | Replace drain pump |
| Cycle light does not light while cycle runs | Defective cycle light | Replace cycle light (amber) |
| Power light does not light but machine runs | Defective power light | Replace power light (red) |
| Wash tank or final rinse temperature does not display | Defective temperature display | Replace temperature display |

| PROBLEM | LIKELY CAUSE | SOLUTION |
|---|-----------------------------------|---------------------------------|
| Both the wash tank temperature and the final rinse temperature do not display | Defective thermometer transformer | Replace thermometer transformer |
| Wash tank or final rinse displays wrong temperature | Defective temperature display | Replace temperature display |
| | Defective thermistor | Replace thermistor |

*The timer assembly motor or micro switches can be replaced independently.



4. Parts Kit

4.1. Initial Parts Kit

| P/N | DESCRIPTION | Qty |
|----------|--|-----|
| 15504.00 | Motor Contactor, 2-Pole 20 Amp | 1 |
| 15504.50 | Heater Contactor, 2-Pole 35 Amp | 1 |
| 00501.00 | 2-Minute Timer Motor | 1 |
| 00631.00 | Ice Cube Relay 120 V | 1 |
| 41015.00 | Solenoid Valve ¼" 120V | 1 |
| 15523.00 | Rocker Switch Start Momentary | 1 |
| 00421.89 | Rocker Switch Drain | 1 |
| 15524.00 | Rocker Switch Power Maintained | 1 |
| 00556.10 | Reed Switch | 1 |
| 03623.00 | 1/2" Vacuum Breaker Repair Kit – Watts | 1 |
| 04113.00 | L1X/L1-C Drain Valve 120V | 1 |
| 00206.70 | Pump Seal Kit | 1 |
| 13417.89 | Heater Thermostat | 1 |
| 17523.60 | High Limit Switch 200°F | 1 |
| 00411.00 | Microswitch | 1 |
| 03203.01 | Dual Temperature Display Kit | 1 |
| 00738.15 | Solenoid Coil JE 115V/60Hz | 1 |
| 00404.82 | Motor Mini Contactor | 1 |



5. Customer Notice

CMA-181VL Installation Guidelines

Improper installation of this product may void the warranty on this machine. Please follow these guidelines for recommended installation and to ensure the warranty of this model is authorized by CMA Dishmachines.

Glasswasher Installation Requirements

1. Unit **must** be level. Adjust leveling feet to accommodate uneven floor surfaces.
2. Drain height should not exceed maximum height of 16". If there is a floor drain, it is highly recommended the pump drain be removed. Connect supplied drain line to 3-way valve on back of machine and gravity feed to the floor drain.
3. Approximately 4-feet of $\frac{3}{4}$ " flexible conduit with power leads (L-1, L-2, Neutral and Ground) extending out of the conduit are provided for easily connecting the power at installation. CMA recommends a minimum 50-amp dedicated circuit, but you should consult your local building code requirements for proper breaker size.

6. Electrical Diagram

6.1. Control Panel

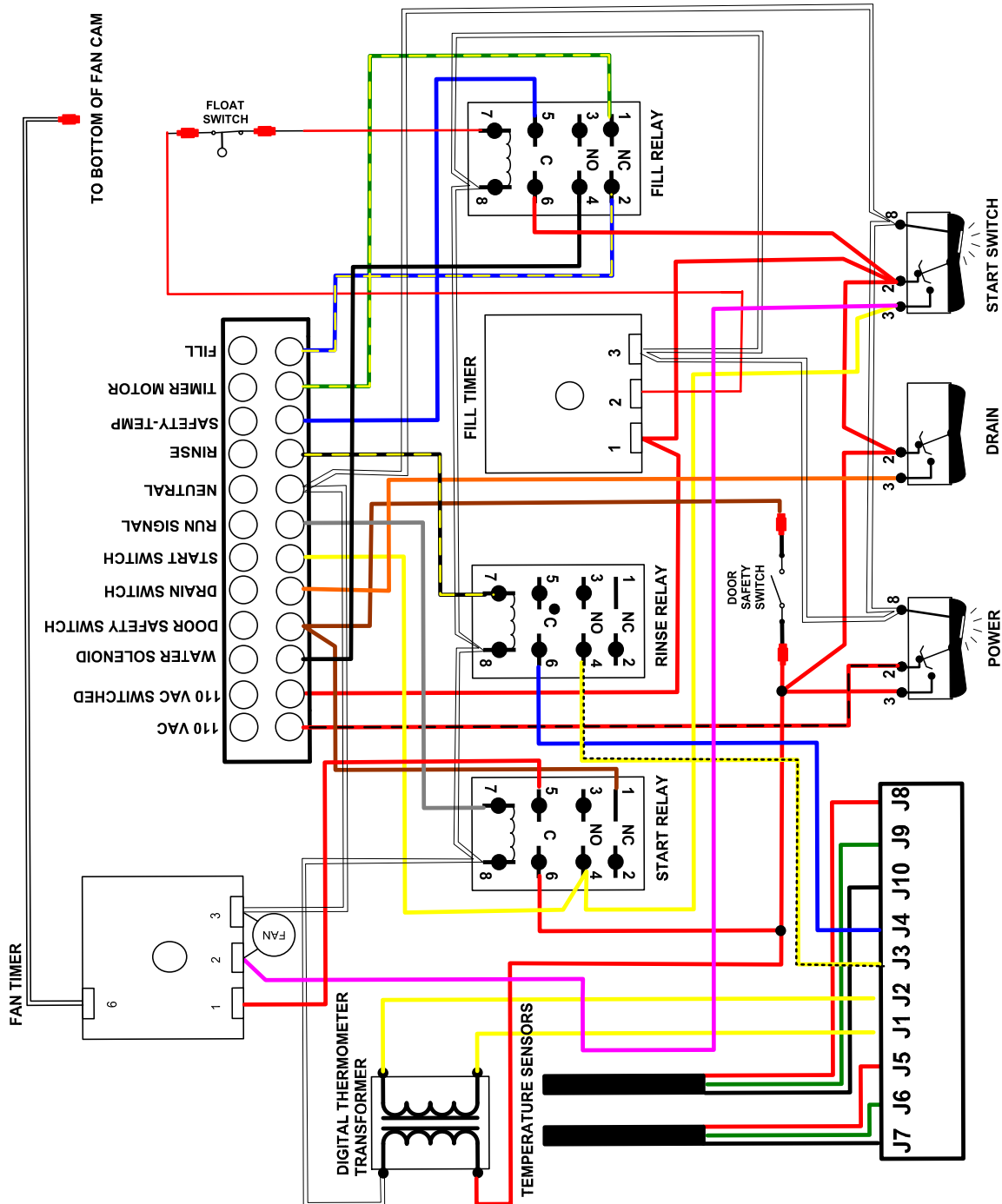

6.2. Electrical Tray

