

Models EAH, EC, EAH-T, EC-T

Quick Setup Instructions

WARNING: Electrical and plumbing connections need to be made by a licensed service person and comply with all Federal, State and Local Health, Electrical, Plumbing and Safety codes.

MODEL "E" REAR VIEW

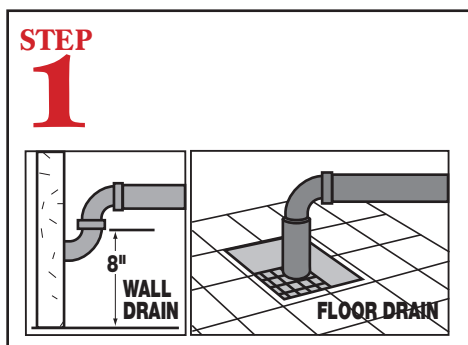
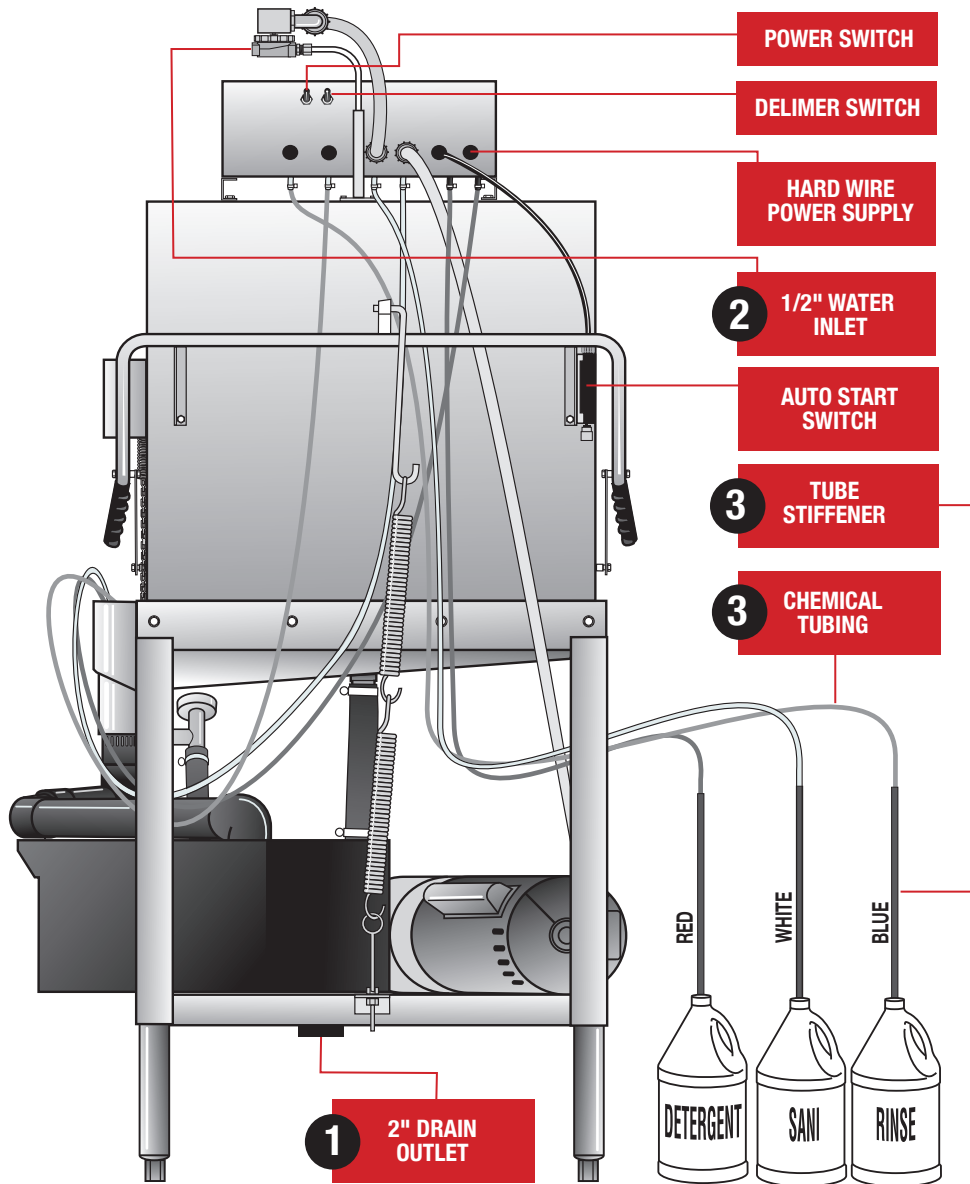

Connect a 2" drain pipe (not supplied) from scrap accumulator to floor or wall drain.

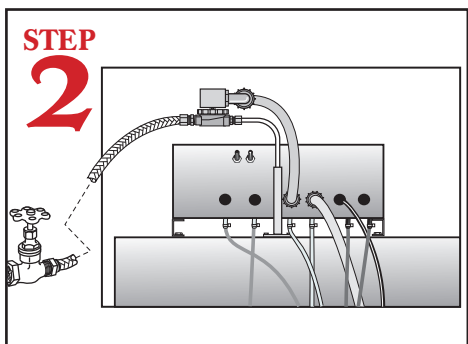

Connect dishmachine to hot water source (minimum 120-140 temperature required).

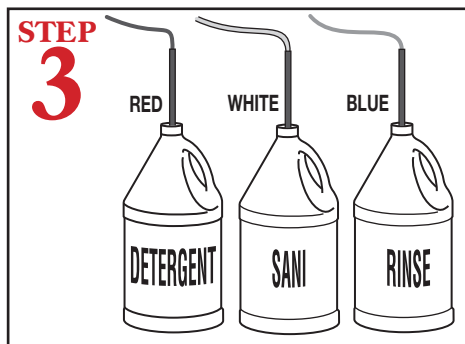

Insert tube stiffener with chemical tubing into each corresponding chemical dispensers.



Models EAH, EC, EAH-T, EC-T Quick Setup Instructions

MODEL "E" FRONT VIEW



WARNING: Electrical and plumbing connections need to be made by a licensed service person and comply with all Federal, State and Local Health, Electrical, Plumbing and Safety codes.

PERISTALTIC PUMP

SANI/DETERGENT SWITCH

RINSE SWITCH

CYCLE LIGHT

FILL/START SWITCH **5**

DOOR HANDLE **6**

THERMOMETER NEEDS TO BE INSTALLED:
The Models E-AH and C are Shipped from CMA without thermometer being installed. To prevent leaking, the installation Team will need to install it on the dishwasher using TEFLON TAPE. So the thermometer for this unit is not misplaced during shipment, please find thermometer shipped inside the dishwasher, zip-tied to the dishrack.

4 LEVELING LEGS

POLY PRO™ SCRAP ACCUMULATOR

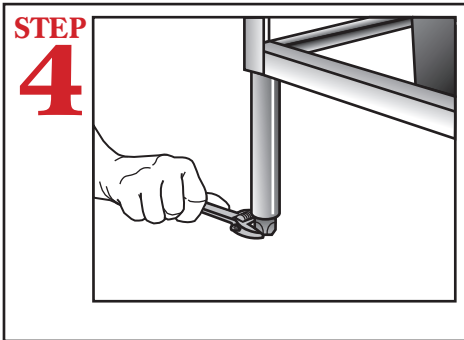
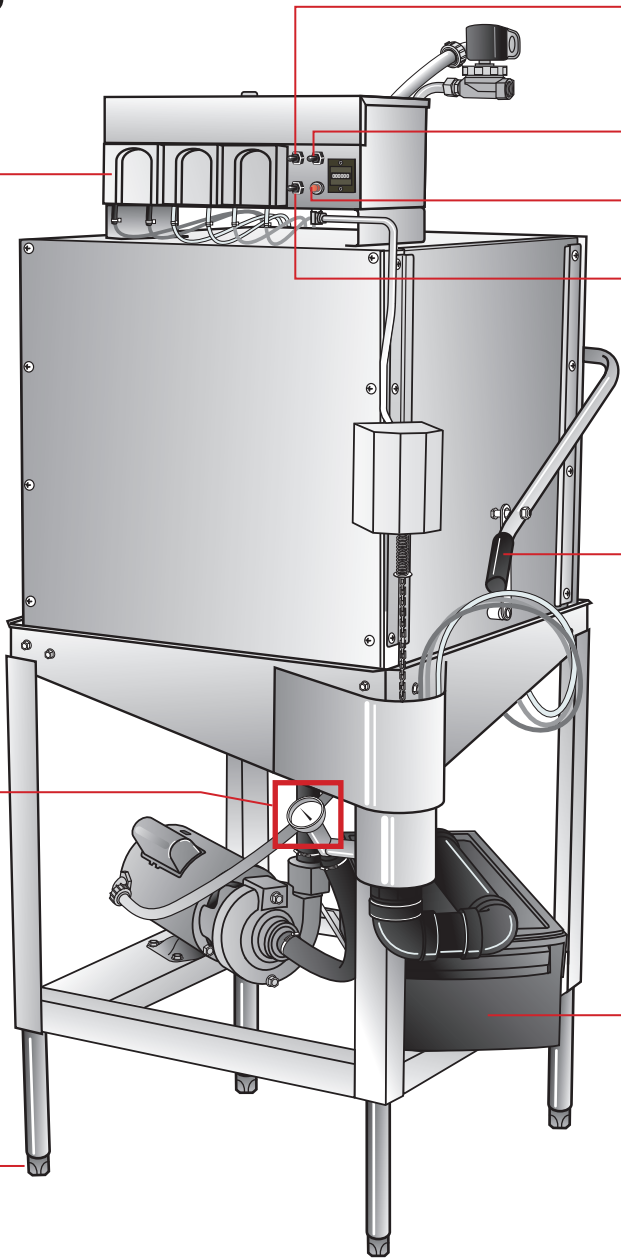

Level dishmachine by adjusting leveling legs. Dishmachine must be level front and back to ensure proper performance.

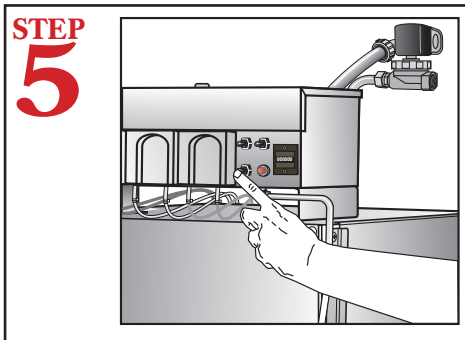

Press and hold the Fill/Start Switch until the water level is approximately 1/2" to 3/4" below the overflow hole in the PVC standpipe.

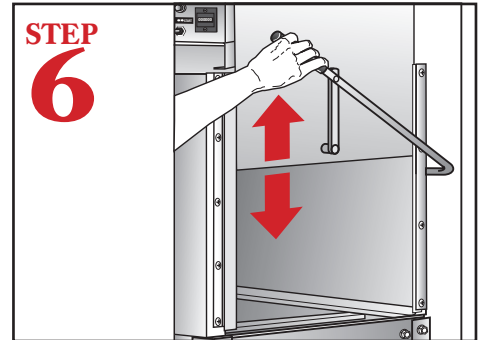

Open dishmachine doors completely. Closing the doors will automatically activate the machine.